

Florence Back to Wall Bath



SPECIFICATIONS

Code	Size	Capacity	Net Weight	Gross Weight
BTF1400	1400mm x 750mm x 590mm	265 Litres	42 Kg	50 Kg

FEATURES

- Modern slim edge design
- Internal steel support frame
- UV Stablised Sanitary grade acrylic
- Adjustable steel legs
- Lumbar support
- Fittings/Pop up is not included
- 10 YR Warranty



COLORS

- Gloss white

MAINTENANCE & CARE

- Clean with mild soapy water using a microfibre cloth after every use.
- Do not use harsh and abrasive detergents, liquids, or pastes.
- Do not use excessive pressure while cleaning.
- Add essential oils only after the water has run in the bath. Spot test using a drop of essential oil on a concealed area of the bathtub to ensure they won't stain the bath.

INSTALLATION MANUAL

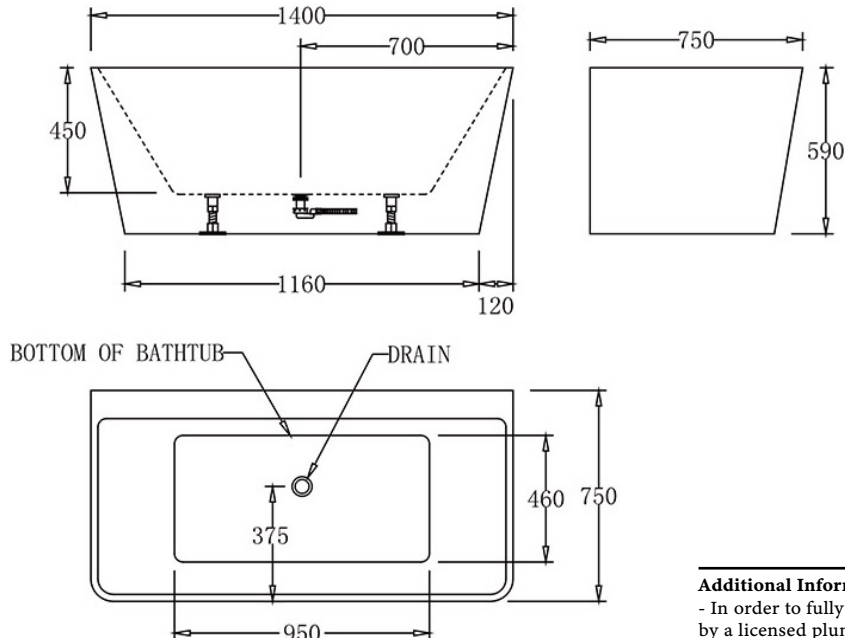

Additional Information:

- In order to fully benefit from warranty claims, please ensure products are installed by a licensed plumber.
- All measurements are in millimeters.
- Dimensions are nominal and subject to normal manufacturing variations. Please

allow +/- 15 mm tolerance.

- For mark-ups & roughing-in, always use actual product measurement.
- Specifications may vary without notice as part of our continuous improvement practices.