

Atlanta Back to Wall Spa Bath



SPECIFICATIONS

Code	Size	Capacity	Net Weight	Gross Weight
BTA1400-SPA	1400mm x 750mm x 590mm	250 Litres	45 Kg	53 Kg

SPA PUMP SPECIFICATIONS



Dimensions	384 x 148 x 198 mm
Voltage	230-240V
Power	750W
Heater	700W
Current	7.5A
db Rating	65db

MAINTENANCE & CARE

- Clean with mild & warm soapy water using a microfibre cloth after every use.
- Perform maintenance clean every three months by adding bi-carb soda or SpaGiene to a bath filled with water and running the spa for 30 minutes.
- Do not use harsh and abrasive detergents, liquids, or pastes.
- Do not use excessive pressure while cleaning.
- Do not use any essential oils, bath oils or oily products.
- Do not run your spa pump without water.

FEATURES

- Gloss white colour
- Modern slim edge design
- Internal steel support frame
- UV Stablised Sanitary grade acrylic
- Adjustable steel legs
- Lumbar support
- Fittings/Pop up not included
- 10 years warranty bath shell
- 1 year warranty on spa jets & pump

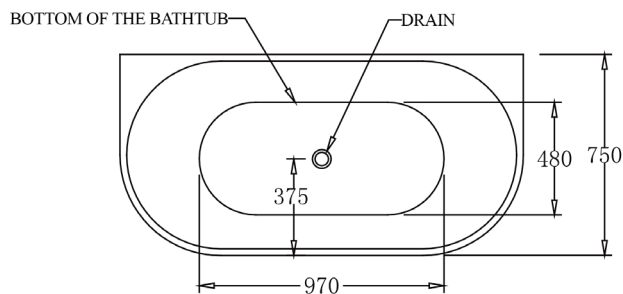
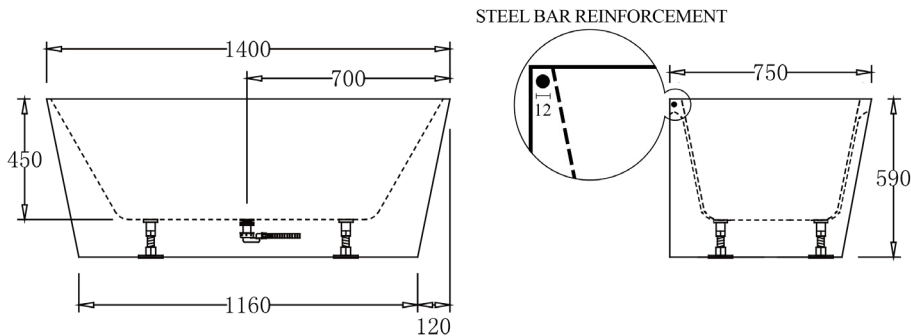

Additional Information:

- In order to fully benefit from warranty claims, please ensure products are installed by a licensed plumber.
- All measurements are in millimeters.
- Dimensions are nominal and subject to normal manufacturing variations. Please allow +/- 15 mm tolerance.

- For mark-ups & roughing-in, always use actual product measurement.
- We recommend that no pre-framing work be carried out until the product is onsite.
- Specifications may vary without notice as part of our continuous improvement practices.